

Attachment Products

Catalog number	Part number	Description
GT-66 	C77220-000	66-ft (20-m) roll of glass tape for attaching heating cable to pipe. Not for stainless-steel pipes or for installation temperatures below 40°F (4.4°C).
GS-54 	C77221-000	54-ft (16.5-m) roll of glass tape for attaching heating cable to pipe. For stainless-steel pipes or for any installation below 40°F (4.4°C).
AT-180 	158139-000	180-ft (55-m) roll of aluminum tape for attaching heating cables and thermostat sensors to pipes and tanks.

Pipe Straps

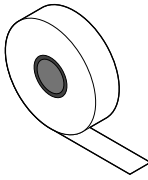
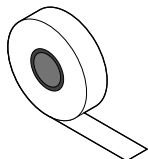
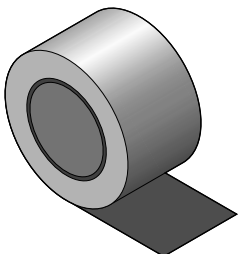
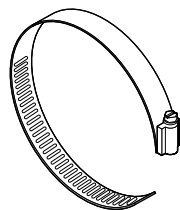

PS-01	C77211-000	1/4–1 in	(6–25 mm)
PS-03	C77212-000	1–2 in	(25–75 mm)
PS-10	C77213-000	2–10 in	(75–250 mm)
PS-20	C77216-000	10–20 in	(250–500 mm)

Used to secure connection components and brackets to pipes. Order by pipe diameter, as shown above.

Labels

Catalog number	Part number	Description
ETL 	C77203-000	“Electric Traced” label for identifying traced pipes and tanks.

Gland Entry Kit

Catalog number	Part number	Description
C75-100-A	000539-0000	A NEMA-4X-rated gland kit used to transition heating cables into a junction box when making connections off of a pipe or tank. It may be used for power, splice, or tee connections. For use with Raychem® brand BTV, QTVR, XTV, KTV, ⁽¹⁾ VPL, and LBTV2-CT ⁽²⁾ heating cables. The kit does not include the junction box, flexible tubing, or tape that are required to make a complete connection.

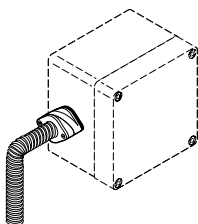
**Kit contents**

Quantity	Description
1	Red grommet
1	Gland with threaded inserts
1	Gland with screws
1	Gland gasket
1	Locknut
1	Green/yellow tube
1	CS-100 core sealer
1	Terminal block

⁽¹⁾ For KTV only, order PMK-GP-10 grommet (P/N 700823).

⁽²⁾ For LBTV2-CT only, order HCS-100-A heat-shrink core sealer (P/N 257649) and PMK-GK-10 grommet (P/N 222724).

Single-Entry Transition Kit

Catalog number	Part number	Description
JS-100-A	166639-0000	Junction box stand for use with Raychem brand BTV, QTVR, XTV, KTV, and VPL heating cables. A separate customer-supplied NEMA 4X junction box is required.

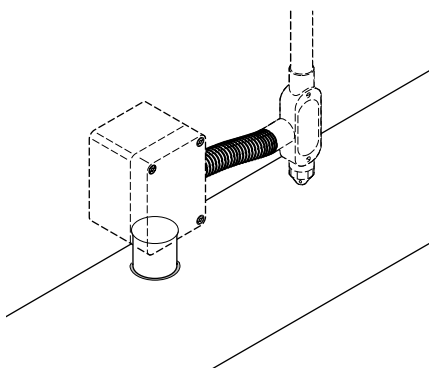
**Kit contents**

Quantity	Description
1	Stand assembly
1	Lubricant
1	Adapter for small pipes
1	Cable tie
1	Green/yellow tube
1	CS-100 cold applied core sealer
1	JS-100 transition
1	1 inch locknut

Cold-Applied Core Sealer

Catalog number	Part number	Description
CS-100-A	232949-0000	Replacement cold-applied core sealer for Raychem brand BTV, QTVR, XTV, KTV, and VPL heating cables.

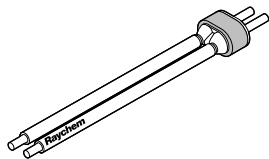

Conduit Drain

Catalog number	Part number	Description
JB-DRAIN-PLUG-3/4IN	278621-000	Tyco Thermal Controls recommends the use of this 3/4-in conduit drain with each JBS-100 and JBM-100, and other enclosures with associated conduits, to prevent condensate from collecting in the box.



Brackets, Adapters

Catalog number	Part number	Description
JBS-SPA	E90515-000	Adapter for mounting E-100, JBS-100, and JS-100 to small pipe, formerly included in the respective kits.



JBM-SPA	D55673-000	Adapter for mounting JBM-100 to small pipe, formerly included in the JBM-100 kit.
---------	------------	---

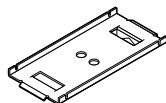

SB-100-T	279613-000	Adapter for mounting E-100, E-100-L, and JBS-100 connection components on a tank surface.
----------	------------	---

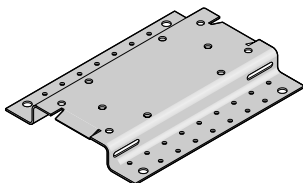

UMB	263757-000	Universal mounting bracket for mounting thermostats and other equipment on a pipe.
-----	------------	--

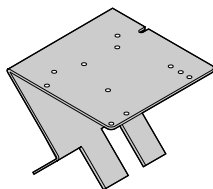

JB-SB-25	471139-000	Stainless-steel mounting bracket for RAYSTAT-EX-03-A thermostat.
----------	------------	--

